



## AM/FM Tuner Module



### TM1 Dealer Installation Guide

# McIntosh

## Overview

The McIntosh TM1 AM/FM Tuner Module adds AM/FM Broadcast Reception to the MX119, MX134 or MX135 A/V Control Centers; the MHT Series A/V System Controllers, C45 Audio Control Center and other McIntosh Components. It also adds functionality of a second Tuner to the MR85 AM/FM Tuner. Follow the instructions in this guide for installing the TM1 into the MX119, MX134, MX135, MHT Series, C45, MR85 and other McIntosh Components. The TM1 Tuner Module is not a user installable product. It must be installed by the Technical Professionals at your McIntosh Dealer.

## Please Take A Moment

The serial number, installation date and Dealer name are important to you for possible insurance claim or future service. The spaces below have been provided for you to record that information:

**Serial Number:** \_\_\_\_\_

**Installation Date:** \_\_\_\_\_

**Dealer Name:** \_\_\_\_\_

## Technical Assistance

If at any time you have questions about installing and/or operating the TM1 AM/FM Tuner Module, contact McIntosh for technical assistance at:

McIntosh Laboratory, Inc.  
2 Chambers Street  
Binghamton, New York 13903  
Phone: 607-723-1545  
Fax: 607-772-3308

## Customer Service

If it is determined that your McIntosh product is in need of repair, you can return it to your Dealer. You can also return it to the McIntosh Laboratory Service Department. For assistance on factory repair return procedure, contact the McIntosh Service Department at:

McIntosh Laboratory, Inc.  
2 Chambers Street  
Binghamton, New York 13903  
Phone: 607-723-3515  
Fax: 607-723-1917

## Table of Contents

Overview .....	2
Please Take a Moment .....	2
Technical Assistance and Customer Service .....	2
Important Information .....	2
Table of Contents .....	2
Parts List .....	3
Connector Information .....	3
MX119, MX134 or MX135 Installation Instructions .....	4
MHT Series Installation Instructions .....	6
C45 Installation Instructions .....	8
MR85 Installation Instructions .....	10

## Important Information

- 1. Caution: To prevent the risk of electric shock, first remove the AC Power Cord from the back of the MX119, MX134, MX135, MHT Series, C45, MR85 or other McIntosh Component before removing the top cover.**
- 2. Some of the semiconductor devices (CMOS and NMOS) used in the TM1 Module, MX119, MX134, MX135, MHT Series, C45, MR85 and other McIntosh Components are inherently sensitive to static electricity even when connected in a circuit, and can be permanently damaged by a static electricity discharge. When handling the TM1 and working inside the MX119, MX134, MX135, MHT Series, C45, MR85 or other McIntosh Components, follow the procedures below to insure against static electricity damage.**
  - A. Make sure the MX119, MX134, MX135, MHT Series, C45, MR85 or other McIntosh Components are properly grounded.**
  - B. Use an approved wrist strap that is grounded.**
  - C. Remove the TM1 from the Anti-Static Bag and work with it only after the above conditions have been met.**
  - D. The RAA1 Remote AM Antenna contains the Tuned AM RF Amplifier First Stage Circuitry and is matched to the specific AM/FM Tuner Module.**
- 3. Some of the Installation Instructions in this Dealer Installation Guide are also used for other McIntosh Components. To identify the appropriate Installation Instructions, refer to the label located on the Connector Cover metal plate inside the McIntosh Component. During the installation process this cover is removed, allowing for the AM and FM Antenna Connections.**

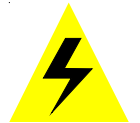

**Parts List**

Part Number	Description	Figure Number
049084	AM/FM Tuner Module	1
034134	Anti-Static Bag	1
049192	RAA1 Remote AM Antenna	2
049443	RAA1 Connection Cable Complete	2
171404	Seven conductor ribbon cable	1
171405	Six conductor ribbon cable	1
171406	Four conductor ribbon cable	1
	TM1 Serial Number Label	1

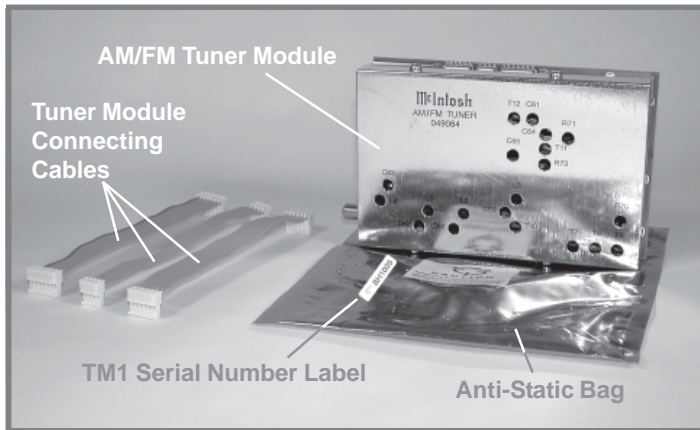

Figure 1

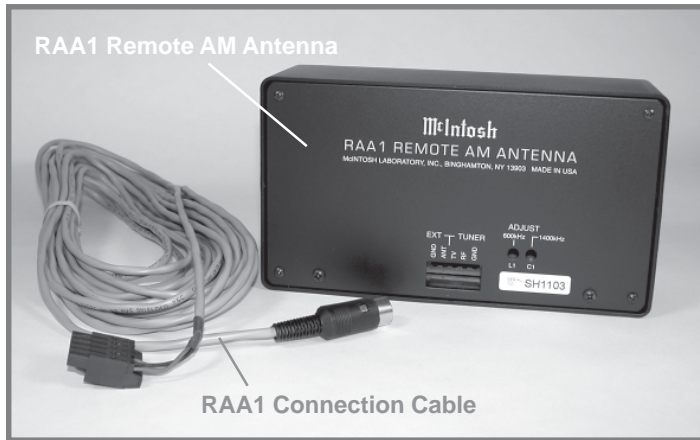

Figure 2

**Connector Information**

**RAA1 Connectors**

Connect the shield and two leads of a shielded 2 conductor cable to the supplied 5 Pin Terminal Connector Plug. Refer to the connection information on the top cover of the RAA1. If there is need to make-up a longer cable, use a two conductor shielded wire and the connectors below.

**5 Pin Terminal Connector**

1. N/C
2. N/C
3. Red Wire
4. Black Wire
5. Green Wire (Shield)

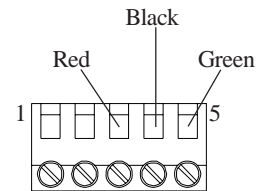

**7 Pin DIN Connector**

1. Red Wire
2. Black Wire
3. N/C
4. N/C
5. N/C
6. Jumper from Pin 7
7. Green Wire (Shield) and Jumper to Pin 6

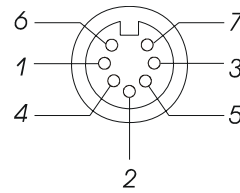

## MX119, MX134 or MX135

### Removing Covers

1. Remove ALL connecting cables from the Rear Panel of the MX119, MX134 or MX135 A/V Controller.
2. Remove two screws from each side and two screws from the back that secure the Top Cover to the MX119, MX134 or MX135.
3. Lift off the Top Cover by grasping the rear sides of the top cover and lifting up and away from the MX119, MX134 or MX135.
4. Remove the Inside Connector Cover which is secured with two Phillips Head Screws and is located on the Rear Panel. Refer to figures 3 and 4.



Figure 3

*Note: Retain the two screws as they will be used later to install the AM/FM Tuner Module.*

### Installing the Cables and Module

5. Locate the three supplied ribbon cables from the shipping carton and attach the plug of the Six Conductor Ribbon Cable to the six pin Socket "J3" as indicated on the MX119, MX134 or MX135 Data PC Board. Refer to figure 1 on page 3 and figure 4 on this page.

*Note: The six pin Cable Plug and PC Board Socket are "keyed" to attach only in one direction, do not force it on backward.*

6. In a similar fashion, attach the plug of the Four Conductor Ribbon Cable to the four pin PC Board Socket "J2" and the plug of the Seven Conductor Ribbon Cable to the seven pin Socket "J1".
7. Relocate the free ends of the previously installed cables and rotate them over the top and to the right of the attached cable ends. Refer to figure 5.
8. Locate the AM/FM Tuner Module in the anti-static bag.

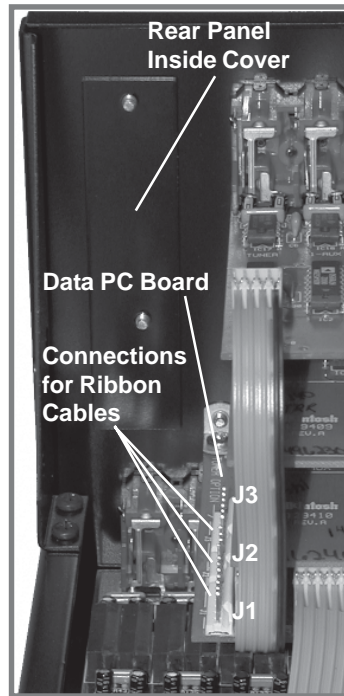

Figure 4

There is a TM1 Serial Number Label attached to the outside of the bag. Refer to figure 1. Remove the label from the bag and attached it to the Rear Panel of the MX119, MX134 or MX135 below the chassis opening labeled RAA1 AM ANT (DIN Connector). Refer to figure 6.

9. Remove the AM/FM Tuner Module from the anti-static bag. Refer to figure 1.
10. Orient the Module so the "F" Connector, that is at the bottom of the Module, will fit through the lower opening of the MX119, MX134 or MX135 Rear Panel (the cover was previously removed in Step 4) and the three PC Board Connectors are facing up. Refer to figures 5 and 6.

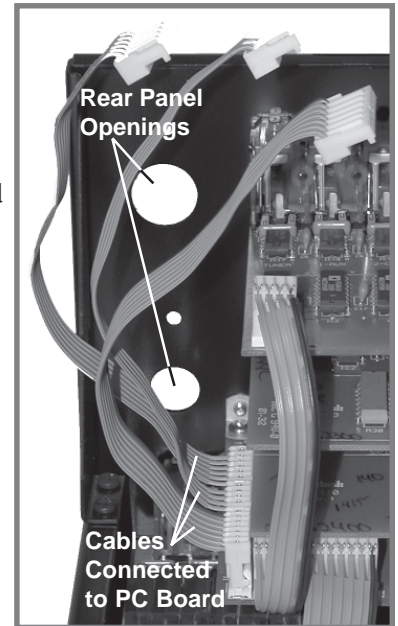

Figure 5



Figure 6

11. Secure the Module to the MX119, MX134 or MX135 Rear Panel with the two Phillips Head Screws that were previously removed from the

12. Attach the plug of the Six Conductor Ribbon Cable coming from the six pin Socket "J3" (as indicated on the MX119, MX134 or MX135 Data PC Board) to the six pin Socket (J4) of the Module, which is located

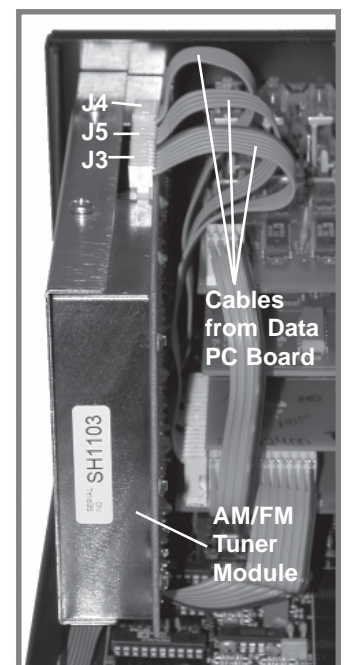

Figure 7

closest to the MX119, MX134 or MX135 Rear Panel. Refer to figure 7.

*Note: The six pin Cable Plug and PC Board Socket are “keyed” to attach only in one direction, do not force it on backward.*



Figure 9

13. In a similar fashion, attach the plug of the Four Conductor Ribbon Cable coming from the four pin Socket “J2” (as indicated on the MX119, MX134 or MX135 Data PC Board) to the four pin Socket (J5) of the Module, which is the middle one of the three in-line connectors.



Figure 10

14. Also attach the remaining plug of the Seven Conductor Ribbon Cable coming from the seven pin Socket “J1” (as indicated on the MX119, MX134 or MX135 Data PC Board) to the seven pin Socket (J4) of the Module, which is located closest to the MX119, MX134 or MX135 Front Panel.



Figure 11

### Reinstalling Cover and Setup

In the following steps the MX119, MX134 or MX135 SETUP feature will be accessed to select the country of operation for proper AM and FM reception. The SETUP Mode is On-Screen Video based menu and it will be required to connect the MX119, MX134 or MX135 MONITOR A Video Output (S-Video or Composite) to a TV/ Monitor. Refer to figures 8 through 13.

15. Reinstall the MX119, MX134 or MX135 Top Cover (refer to Steps 2 and 3 on page 3).
16. Reconnect the hookup Connecting Cables to the Rear Panel of the MX119, MX134 or MX135.
17. Place the MX119, MX134 or MX135 Main POWER Switch to the ON position and press the STANDBY/ ON Push-button.

*Note: Refer to the MX119, MX134 or MX135 Owner’s Manual for additional Operational Details.*



Figure 12



Figure 8

18. Press the SETUP Push-button to enter the Setup Mode.
19. Press and release both TUNING Up and Down Push-buttons and “NO TUNER” will appear on the Front Panel Alphanumeric Display. Refer to figure 9.
20. Press and release both TUNING Up and Down Push-buttons until “USA” appears on the Front Panel Alphanumeric Display. Refer to figure 10.

*Note: If this MX119, MX134 or MX135 is being operated in a country other than the USA, select the appropriate country group. Refer to figures 11 and 12.*



Figure 13

21. Select EXIT from the Main System Setup Menu and select YES to save the Changes. Refer to figure 13.
22. Verify the AM and FM Tuner is functioning properly.

## MHT Series Component

### Removing Covers

1. Remove ALL connecting cables from the Rear Panel of the MHT Series A/V System Controller.
2. Remove two screws from each side and two screws from the back that secure the Top Cover to the MHT Series Component.
3. Lift off the Top Cover by grasping the rear sides of the top cover and lifting up and away from the MHT Series Component.
4. Remove the Inside Connector Cover which is secured with two Phillips Head Screws and is located on the Rear Panel. Refer to figures 10 and 11.



Figure 10

*Note: Retain the two screws as they will be used later to install the AM/FM Tuner Module.*

### Installing the Cables and Module

5. Locate the three supplied ribbon cables from the shipping carton and attach the plug of the Six Conductor Ribbon Cable to the six pin "J3" as indicated on the MHT Series Component Main Audio PC Board. Refer to figures 1 (on page 3) and 12.

*Note: The six pin Cable Plug and PC Board Socket are "keyed" to attach only in one direction, do not force it on backward.*



Figure 11

6. In a similar fashion, attach the plug of the Four Conductor Ribbon Cable to the four pin PC Board Socket "J2" and the plug of the Seven Conductor Ribbon Cable to the seven pin PC Board Socket "J1".

7. Relocate the free ends of the previously installed cables so that they will not interfere with the installa-

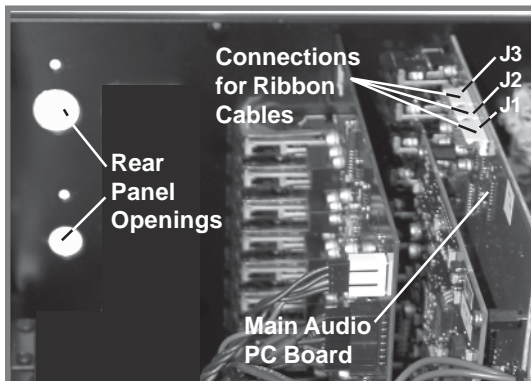

Figure 12

8. Locate the AM/FM Tuner Module. Refer to figure 13.

9. Remove the AM/FM Tuner Module from the anti-static bag. There is a TM1 Serial Number Label attached

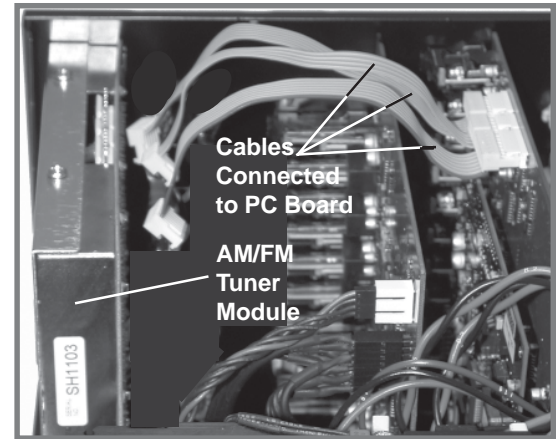

Figure 13

to the outside of the bag. Refer to figure 1 on page 3. Remove the label from the bag and attached it to the Rear Panel of the MHT Series Component below the opening labeled RAA1 AM ANT (DIN Connector). Refer to figure 14.

9. Remove the AM/FM Tuner Module from the anti-static bag. Refer to figure 1 on page 3.
10. Orient the Module so the "F" Connector, that is at the bottom of the Module, will fit through the lower opening of the MHT Series Component Rear Panel (the cover was previously removed in Step 4) and the three PC Board Connectors are facing up. Refer to figures 13 and 14.
11. Secure the Module to the MHT Series Component Rear Panel with the two Phillips Head Screws that were previously removed from the rear panel in Step 4.



Figure 14

12. Attach the plug of the Six Conductor Ribbon Cable coming from the six pin Socket "J3" (as indicated on the MHT Series Component Main Audio PC Board) to the six pin PC Board Socket (J3) of the Module, which is located closest to the MHT Series Component Rear Panel. Refer to figure 13.

*Note: The six pin Cable Plug and PC Board Socket are "keyed" to attach only in one direction, do not force it on backward.*

13. In a similar fashion, attach the plug of the Four Conductor Ribbon Cable coming from the four pin Socket "J2" (as indicated on the MHT Series Component Main

Audio PC Board) to the four pin PC Board Socket (J5) of the Module, which is the middle one of the three in-line connectors.

- Also attach the remaining plug of the Seven Conductor Ribbon Cable coming from the seven pin Socket "J1" (as indicated on the MHT Series

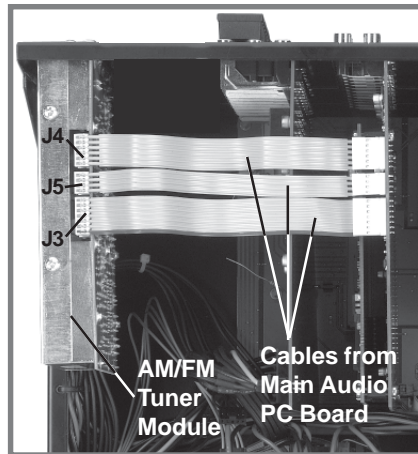

Figure 15

Main Component Audio PC Board) to the seven pin PC Board Socket (J4) of the Module, which is located closest to the MHT Series Component Front Panel.

## Reinstalling Cover and Setup

In the following steps the MHT Series Component SETUP feature will be accessed to select the country of operation for proper AM and FM reception. The SETUP Mode is On-Screen Video based menu and can be viewed by connecting the MHT Series Component MONITOR A Video Output (S-Video or Composite) to a TV/Monitor. This will allow for verifying the Tuner Country setting.

- Reinstall the MHT Series Component Top Cover (refer to Steps 2 and 3 on page 5).
- Secure the MHT Series Component Top Cover to the Rear Panel with the two screws that were previously removed.
- Reinstall the four screws to the sides of the MHT Series Component A/V System Controller.
- Reconnect the hookup Connecting Cables to the Rear Panel of the MHT Series.
- Place the MHT Series Main POWER Switch to the ON position and press the STANDBY/ON Push-button. Refer to figure 16.

*Note: Refer to the MHT Series Component Owner's Manual for additional Operational Details.*

The MHT Series Component Default Operational Setting for the TM1 AM/FM Tuner Module is "USA". To check the current setting perform the following:

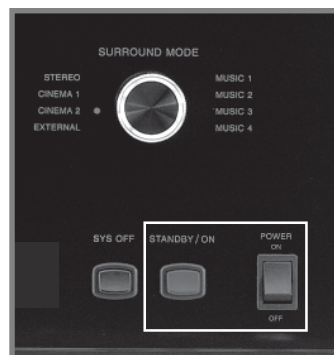

Figure 16

- Press and hold the front panel Setup Push-button approximately three seconds to enter the Setup Mode. The word SETUP will appear on the MHT Series Component Front Panel Display and the MAIN SYSTEM SETUP Menu will appear on the Monitor/TV screen.
- Using the Up▲ or Down▼ directional push-buttons select SYSTEM SETTINGS on the On-Screen Menu, followed by the SELECT Push-button on the Remote Control. The On-Screen Menu Item TUNER indicates the current country setting of the TM1 AM/FM Tuner Module. If it needs to be changed to a different country group perform step 22, if not go to step 23. Refer to figure 17.



Figure 17

*Note: The some MHT Series Components have additional menu items (e.g. OSD ROUTING and VIDEO FORMAT) that will not appear on other MHT Series Component On-Screen Menu.*

- With the MHT Series Component in the Standby Mode, press the STANDBY/ON Push-button followed by immediately pressing and holding in the appropriate Front Panel Push-button.

Push-button	Country Group
TRIM Down▼	USA
TRIM Up▲	EUROPE
LATE NIGHT	JAPAN

*Note: The Front Panel Alphanumeric Display will indicate the specific MHT Series Component model number followed by "TUNER USA" or "TUNER EUROPE" or "TUNER JAPAN".*

- Verify the AM and FM Tuner is functioning properly.

## C45

### Removing Covers

1. Remove ALL connecting cables from the Rear Panel of the C45 Audio Control Center.
2. Remove two screws from each side and two screws from the back that secure the Top Cover to the C45.
3. Lift off the Top Cover by grasping the rear sides of the top cover and lifting up and away from the C45.
4. Remove the Inside Connector Cover which is secured with two Phillips Head Screws and is located on the Rear Panel. Refer to figures 18, 19 and 20.

*Note: Retain the two screws as they will be used later to install the AM/FM Tuner Module.*



Figure 18

### Installing the Cables and Module

5. Locate the three supplied ribbon cables from the shipping carton and attach the plug of the Six Conductor Ribbon Cable to the six pin Socket "J23" as indicated on the C45 Main PC Board. Refer to figure 1 on page 3, figures 20 and 21 on this page.

*Note: The six pin Cable Plug and PC Board Socket are "keyed" to attach only in one direction, do not force it on backward.*

*Note: The six pin Cable Plug and PC Board Socket are "keyed" to attach only in one direction, do not force it on backward.*

6. In a similar fashion, attach the plug of the Four Conductor Ribbon Cable to the four pin PC Board Socket "J22" and the plug of the Seven Conductor Ribbon Cable to the seven pin Socket "J21".
7. Relocate the free ends of the previously installed cables and rotate them over the top and to the right of the attached cable ends. Refer to figure 21.
8. Locate the AM/FM Tuner Module in the anti-static bag. There is a TM1 Serial Number Label attached to the outside of the bag. Refer to figure 1 on page 3. Remove the label from the bag and attached it to the Rear Panel of the C45 below the opening labeled RAA1 AM ANT (DIN Connector). Refer to figure 22.

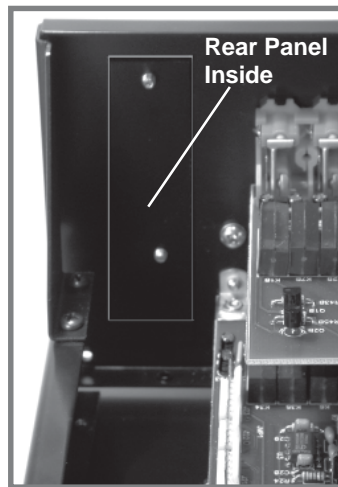

Figure 19

9. Remove the AM/FM Tuner Module from the anti-static bag. Refer to figure 1 on page 3.

10. Orient the Module so the "F" Connector, that is at the bottom of the Module, will fit through the lower opening of the C45 Rear Panel (the cover was previously removed in Step 4) and the three PC Board Connectors are facing up. Refer to figures 21 and 22.

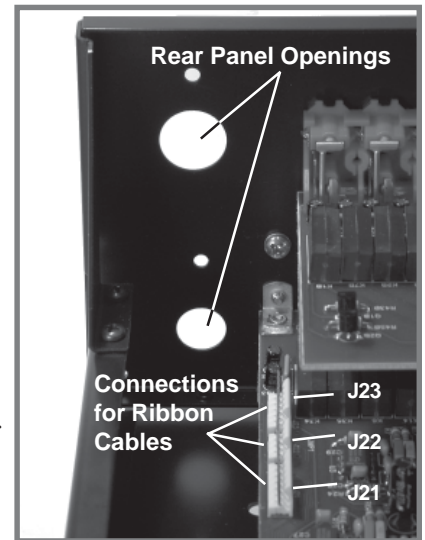

Figure 20

11. Secure the Module to the C45 Rear Panel with the two Phillips Head Screws that were previously removed from the rear panel in Step 4.
12. Attach the plug of the Six Conductor Ribbon Cable coming from the six pin Socket "J23" (as indicated on the C45 Main PC Board) to the six pin Socket of the Module, which is located closest to the C45 Rear Panel. Refer to figure 23.

*Note: The six pin Cable Plug and PC Board Socket are "keyed" to attach only in one direction, do not force it on backward.*

13. In a similar fashion, attach the plug of the Four Conductor Ribbon Cable coming from the four pin Socket "J22" (as indicated on the C45 Data PC Board) to the

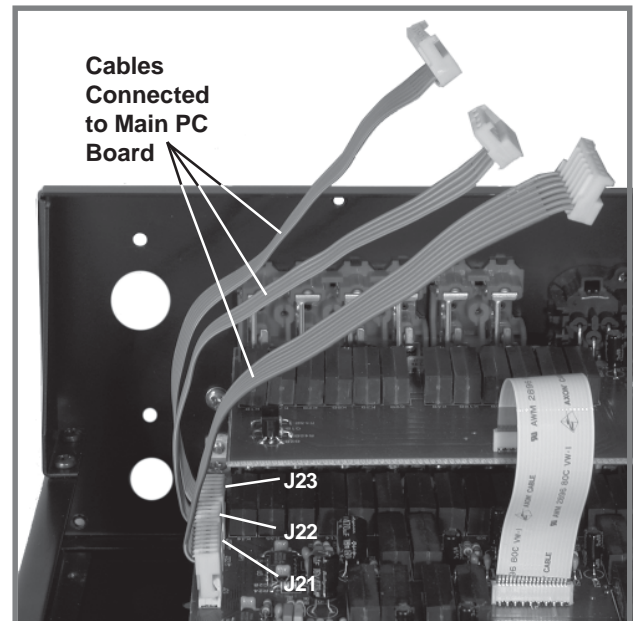

Figure 21



four pin Socket of the Module, which is the middle one of the three in-line connectors.

- Also attach the remaining plug of the Seven Conductor Ribbon Cable coming from the seven pin Socket "J21" (as indicated on the C45 Data PC Board) to the seven pin Socket of the Module, which is located closest to the C45 Front Panel.

**Reinstalling Cover and Setup**

In the following steps the C45 SETUP feature will be accessed to select the country of operation for proper AM and FM reception. The SETUP Mode is indicated on the Front Panel Alpha-numeric Display. Refer to figures 24, 25 and 26.

- Reinstall the C45 Top Cover (refer to Steps 2 and 3 on page 3).
- Reconnect the hookup Connecting Cables to the Rear Panel of the C45.
- Place the C45 Main POWER Switch to the ON position and press the STANDBY/ON Push-button.



Figure 22

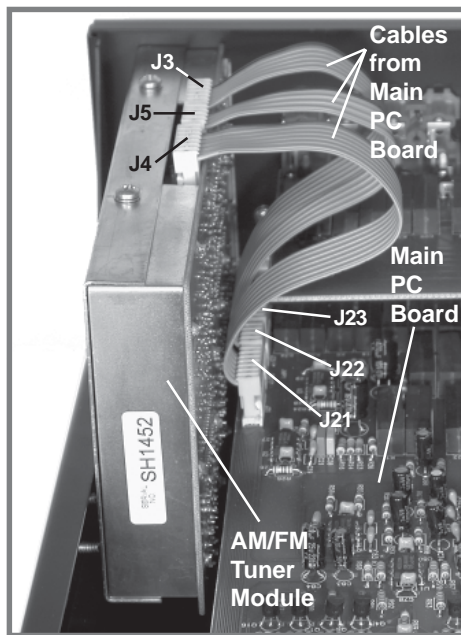

Figure 23

*Note: Refer to the C45 Owner's Manual for additional Operational Details.*

- Press the SETUP Push-button to enter the Setup Mode.
- Press the MENU (TONE BYPASS) Push-button and the last selected Setup Mode will appear on the Front Panel Alpha-numeric Display. If necessary continue to press the MENU Push-button until "VERSION \_.\_ \_" appears on the Display. The character on the far right side of the Firmware Version Number display indicates which country the Tuner is setup for proper operation. Refer to figure 24.

Alphanumeric Display	Country Group
VERSION _._ U	USA
VERSION _._ J	JAPAN
VERSION _._ E	EUROPE

*Note: If the character on the far right side of the display is an "U" the Tuner is set for reception in the USA.*

If the Tuner is setup for the country it will be operated in proceed to step 23, if not then perform the following steps first:

- Press the MENU Push-button until the Front Panel Alpha-numeric Display indicates COUNTRY CODE. Refer to figure 25.



Figure 25

- Press the TRIM LEVEL UP▲ or DOWN▼ Push-button to change the Country Group. Refer to figure 26.



Figure 26

- Press the SETUP Push-button to exit the Setup Mode.
- Verify the AM and FM Tuner is functioning properly.



Figure 24

## MR85

### Removing Covers

1. Remove ALL connecting cables from the Rear Panel of the MR85 AM/FM Tuner.
2. Remove two screws from each side and two screws from the back that secure the Top Cover to the MR85.
3. Lift off the Top Cover by grasping the rear sides of the top cover and lifting up and away from the MR85.
4. Remove the Inside Connector Cover which is secured with two Phillips Head Screws and is located on the Rear Panel. Refer to figures 27 and 28.

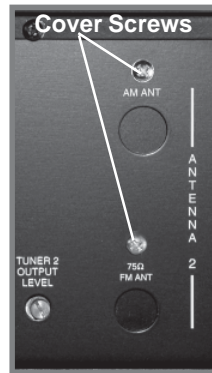

Figure 27

*Note: Retain the two screws as they will be used later to install the AM/FM Tuner Module.*

### Installing the Cables and Module

5. Locate the three supplied ribbon cables from the shipping carton and attach the plug of the Six Conductor Ribbon Cable to the six pin PC Board Socket "J3" as indicated on the MR85 Main PC Board. Refer to figure 1 (on page 3) and figures 29, 31.

*Note: The six pin Cable Plug and PC Board Socket are "keyed" to attach only in one direction, do not force it on backward.*



Figure 28

6. In a similar fashion, attach the plug of the Four Conductor Ribbon Cable to the four pin "J2" and the plug of the Seven Conductor Ribbon Cable to the seven pin Socket "J1".
7. Relocate the free ends of the previously installed cables and rotate them over the top and to the right of the attached cable ends.

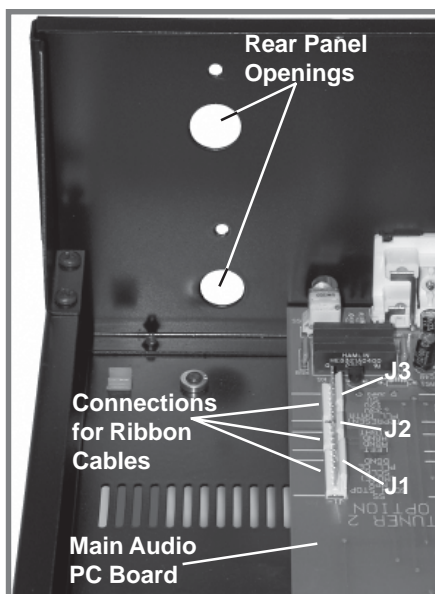

Figure 29

8. Locate the AM/FM Tuner Module in the anti-static bag. There is a TM1 Serial Num-

ber Label attached to the outside of the bag. Refer to figure 1 on page 3. Remove the label from the bag and attached it to the Rear Panel of the MR85 below the opening labeled RAA1 AM ANT (DIN Connector). Refer to figure 30.



Figure 30

9. Remove the AM/FM Tuner Module from the anti-static bag. Refer to figure 1 on page 3.
10. Orient the Module so the "F" Connector, that is at the bottom of the Module, will fit through the lower opening of the MR85 Rear Panel (the cover was previously removed in Step 4) and the three PC Board Connectors are facing up. Refer to figures 29, 30 and 32.

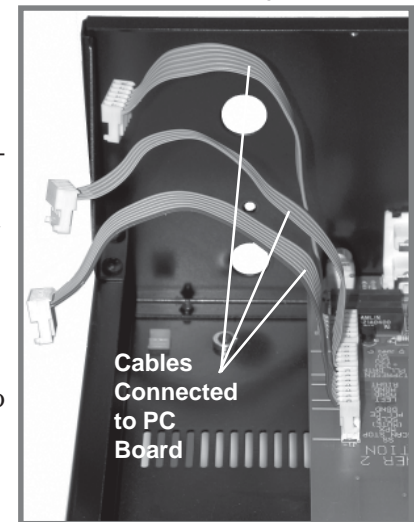

Figure 31

11. Secure the Module to the MR85 Rear Panel with the two Phillips Head Screws that were previously removed from the rear panel in Step 4.

12. Attach the plug of the Six Conductor Ribbon Cable coming from the six pin Socket "J3" as indicated on the MR85 Main PC Board to the six pin Socket "J3" of the Module, which is located closest to the MR85 Rear Panel. Refer to figure 32 and 33.

*Note: The six pin Cable Plug and PC Board Socket are "keyed" to attach only in one direction, do not force it on backward.*

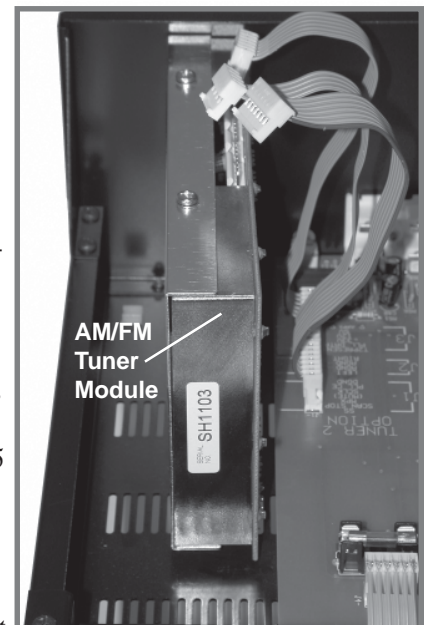

Figure 32

13. In a similar fashion, attach the plug of the Four Conductor Ribbon Cable coming from the six pin PC Board Socket "J2" (as indicated on the MR85 Main PC Board) to the four pin Socket "J5" of the Module, which is the middle one of the three in-line connectors.

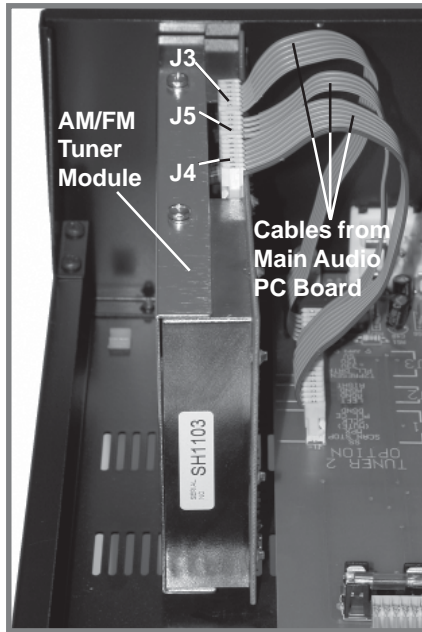

Figure 33

14. Also attach the remaining plug of the Seven Conductor Ribbon Cable coming from the seven pin PC Board Socket "J1" (as indicated on the MR85 Main PC Board) to the seven pin Socket "J4" of the Module, which is located closest to the MR85 Front Panel.

18. Press and hold in the SPATIAL and MONO Push-buttons until the Front Panel Alphanumeric Display indicates "SETUP V\_ \_ \_". The character on the far right side of the Firmware Version Number display indicates which country the Tuner is setup for proper operation. Refer to figure 34.

Alphanumeric Display	Country Group
SETUP _ _ U	USA
SETUP _ _ J	JAPAN
SETUP _ _ E	EUROPE

*Note: If the character on the far right side of the display is an "U" the Tuner is set for reception in the USA.*

If the Tuner is setup for the country it will be operated in proceed to step 23, if not then perform the following steps first:

19. Rotate the PRESET Control until the Front Panel Alphanumeric Display indicates COUNTRY CODE. Refer to figure 35.



Figure 35

20. Press the ENTER Push-button repeatedly until the correct Country Group appears. Refer to figure 36.



Figure 36

21. Rotate the PRESET Control until the Front Panel Alphanumeric Display indicates EXIT.

22. Press the ENTER Push-button to save the changes.

23. Verify that AM and FM reception for "TUNER 2" is functioning properly.

### Reinstalling Cover and Operation Check

In the following steps the MR85 SETUP feature will be accessed to select the country of operation for proper AM and FM reception. The SETUP Mode is indicated on the Front Panel Alphanumeric Display. Refer to figures 34, 35 and 36.

15. Reinstall the MR85 Top Cover (refer to Steps 2 and 3 on page 10).

16. Reconnect the hookup Connecting Cables to the Rear Panel of the MR85.

17. Place the MR85 Main POWER Switch to the ON position and press the STANDBY/ON Push-button.

*Note: Refer to the MR85 Owner's Manual for additional Operational Details.*



Figure 34



McIntosh Laboratory, Inc.  
2 Chambers Street  
Binghamton, NY 13903

The continuous improvement of its products is the  
policy of McIntosh Laboratory Incorporated who  
reserve the right to improve design without notice.  
Printed in the U.S.A.

McIntosh Part No. 04071604